

1

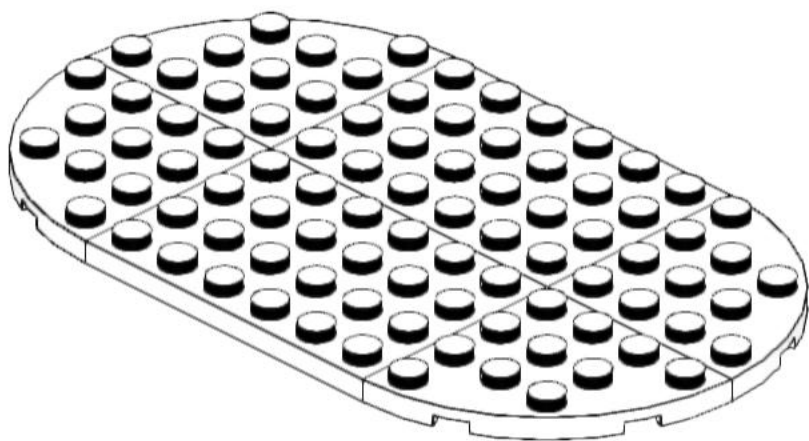

2

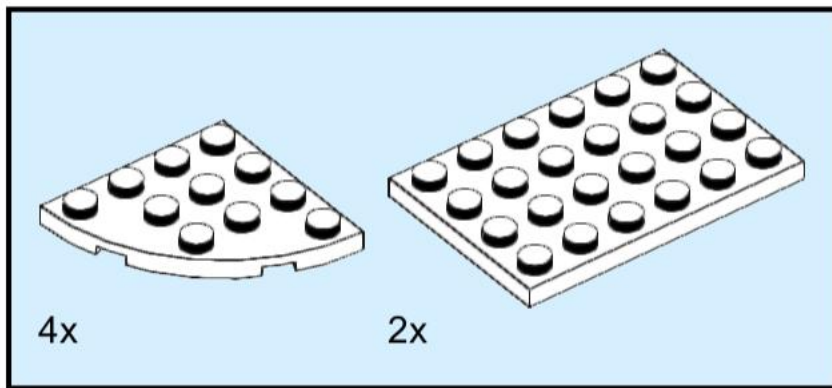
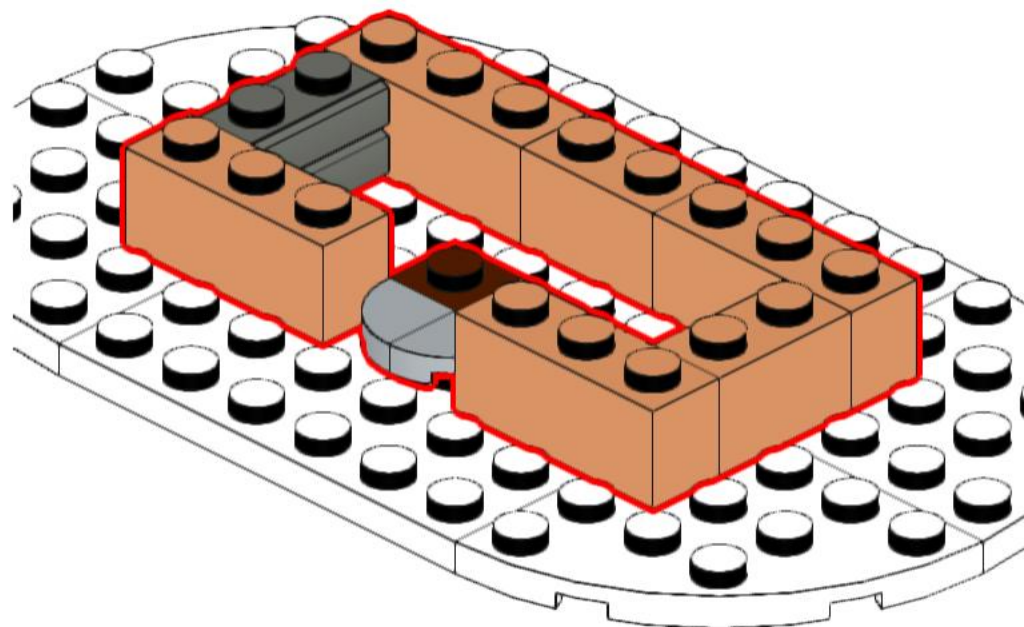
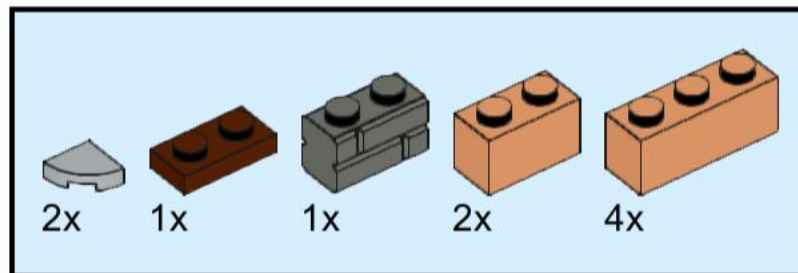

3

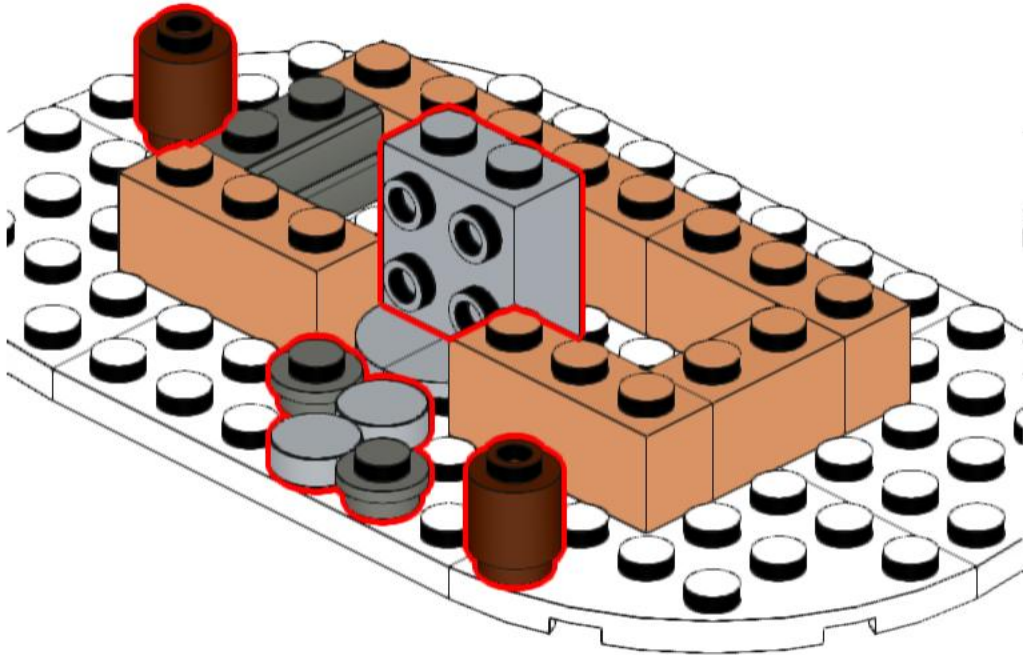
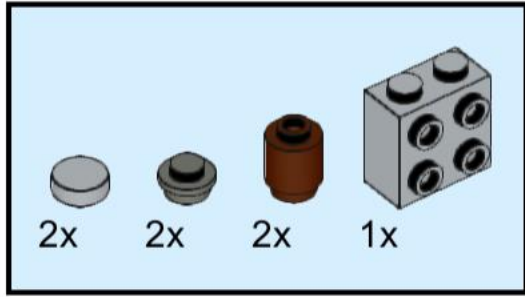

4

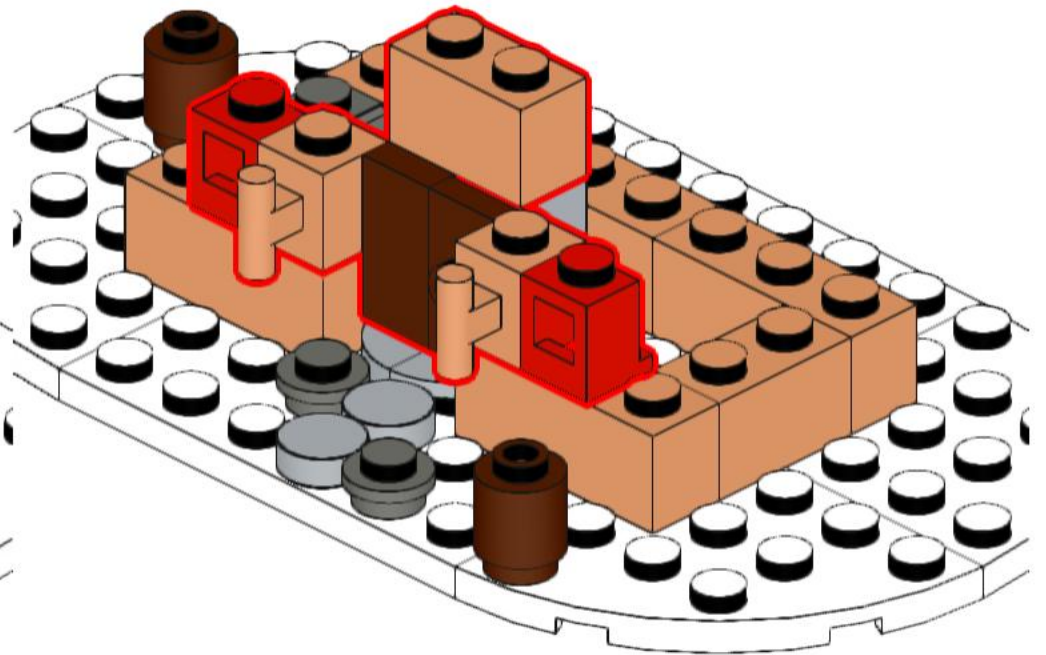
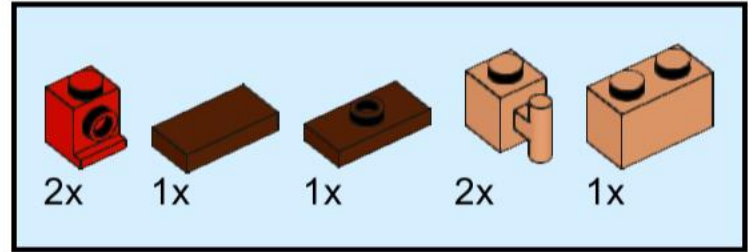

5

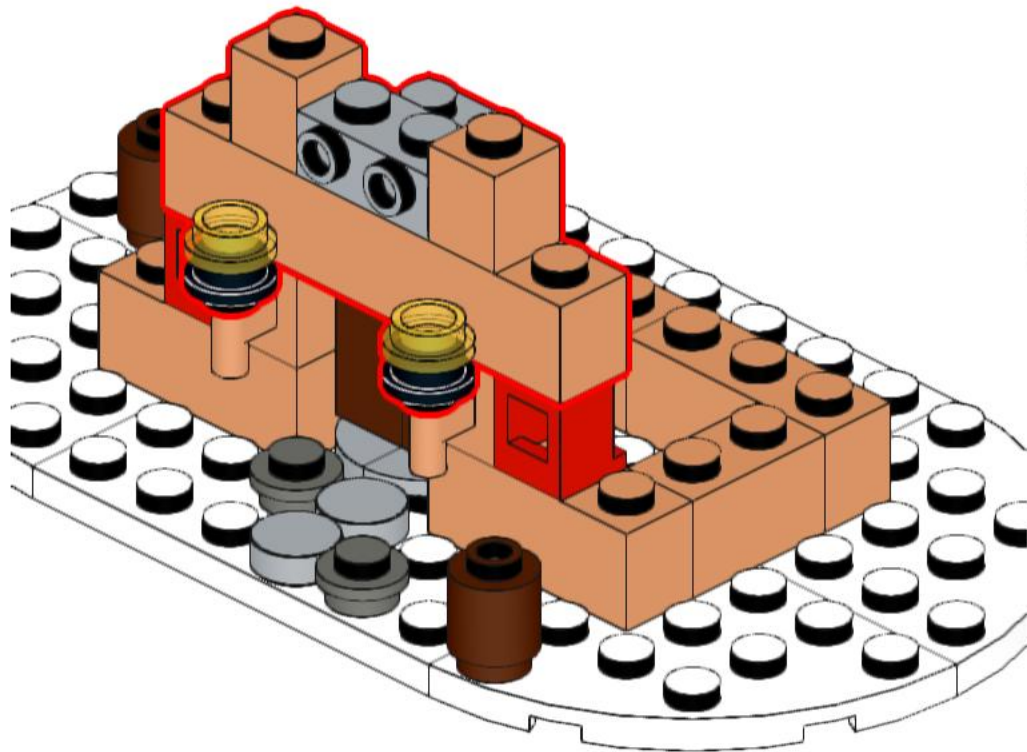
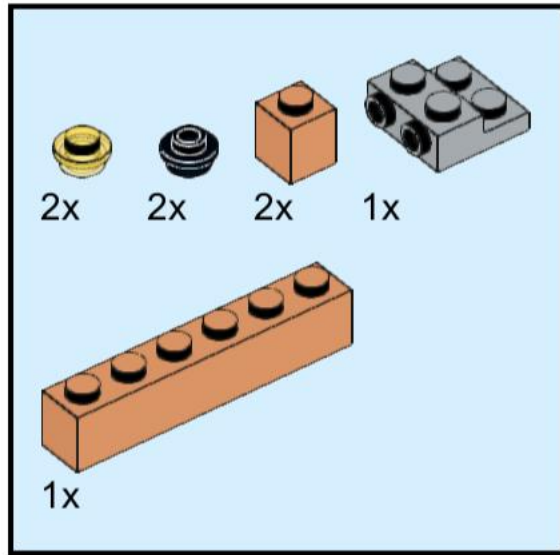

6

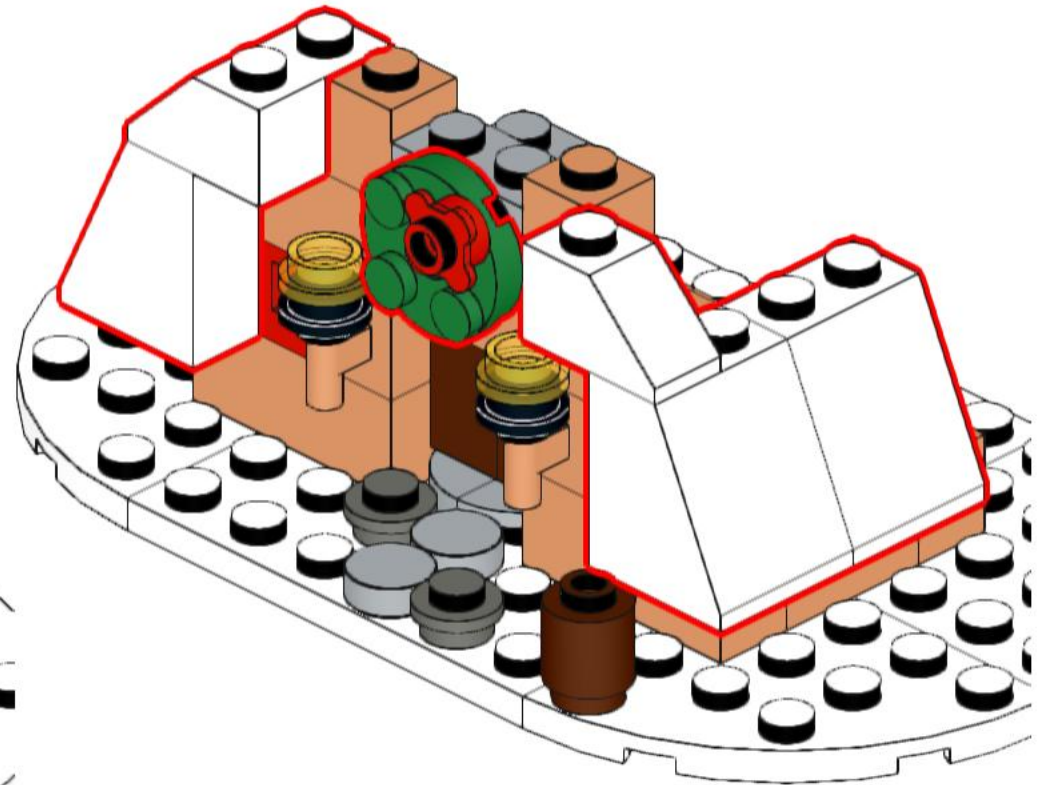
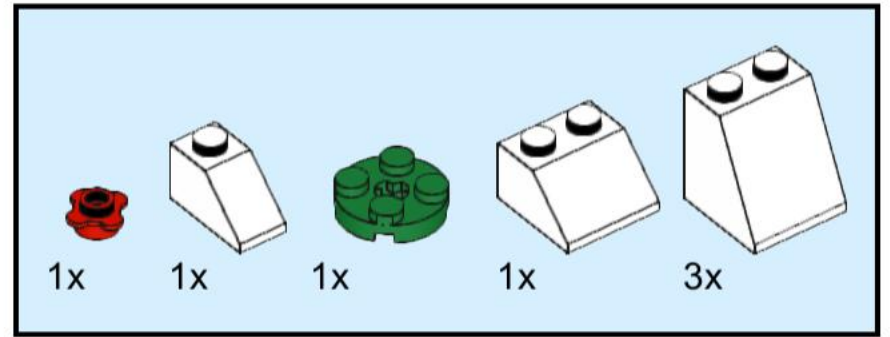

7

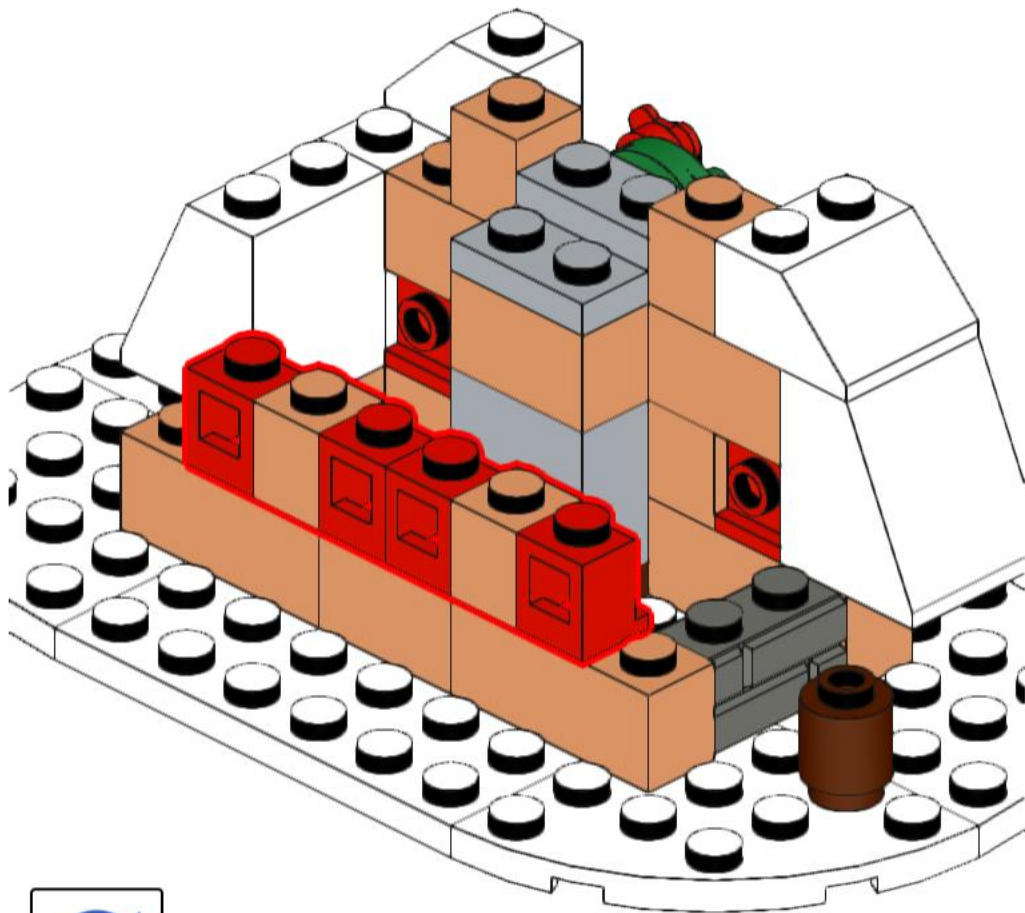
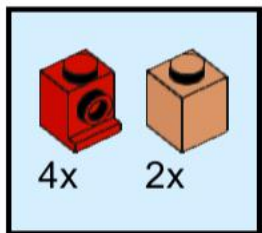

8

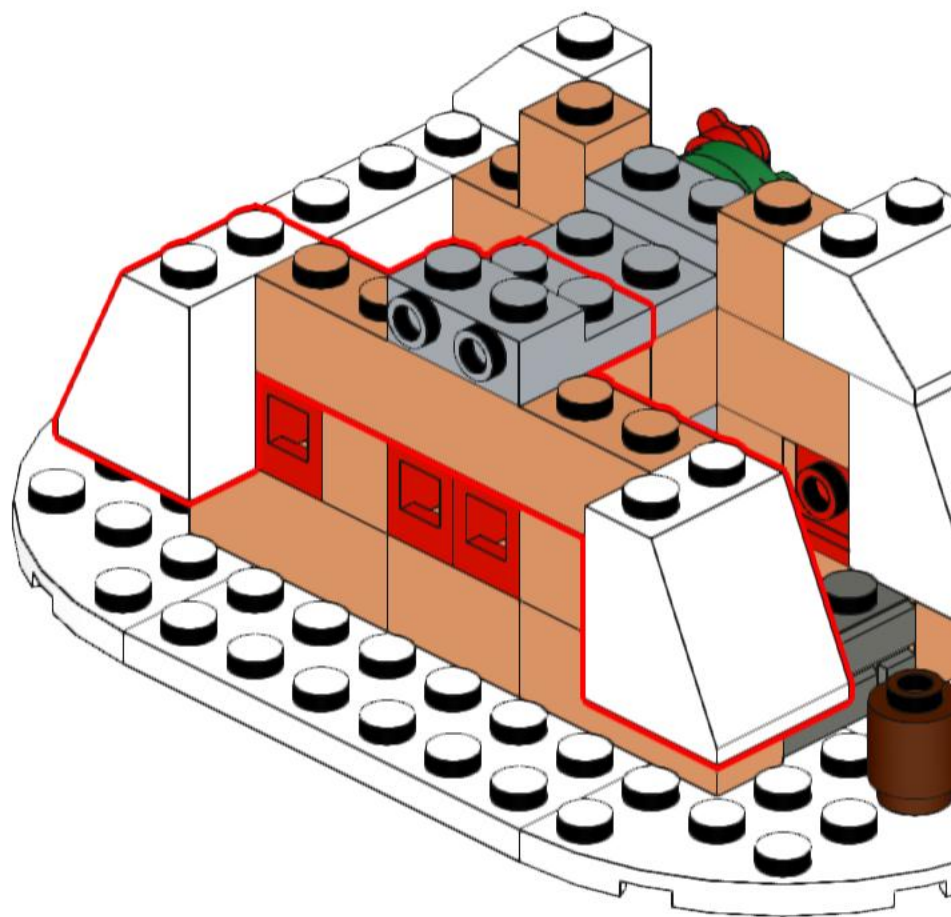
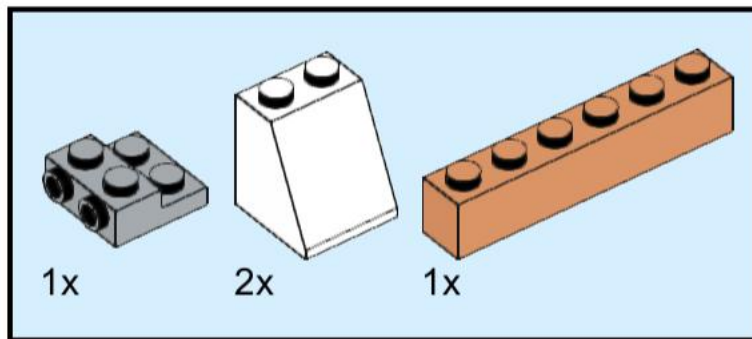

9

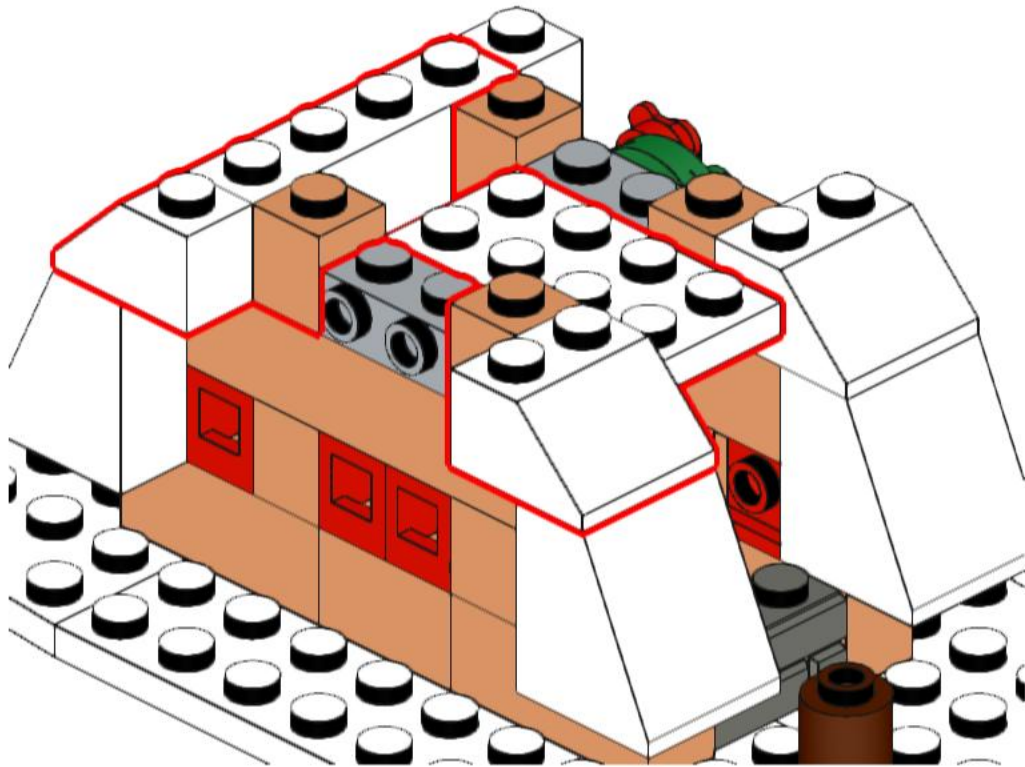
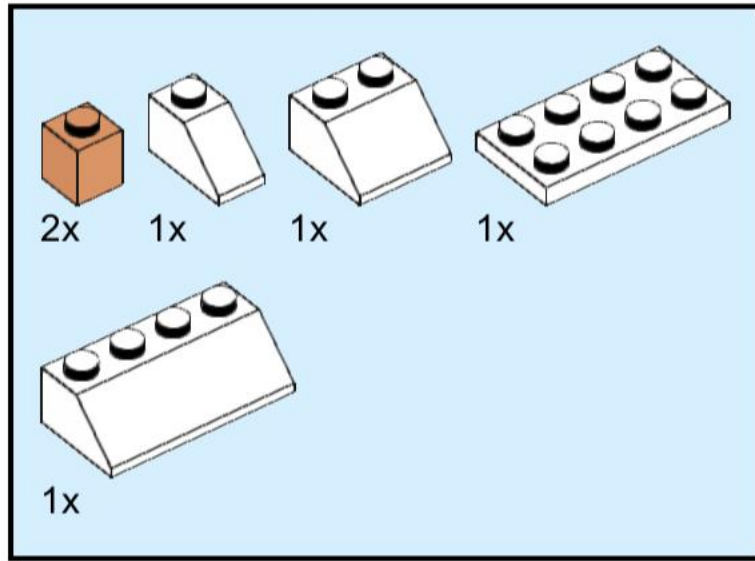

10

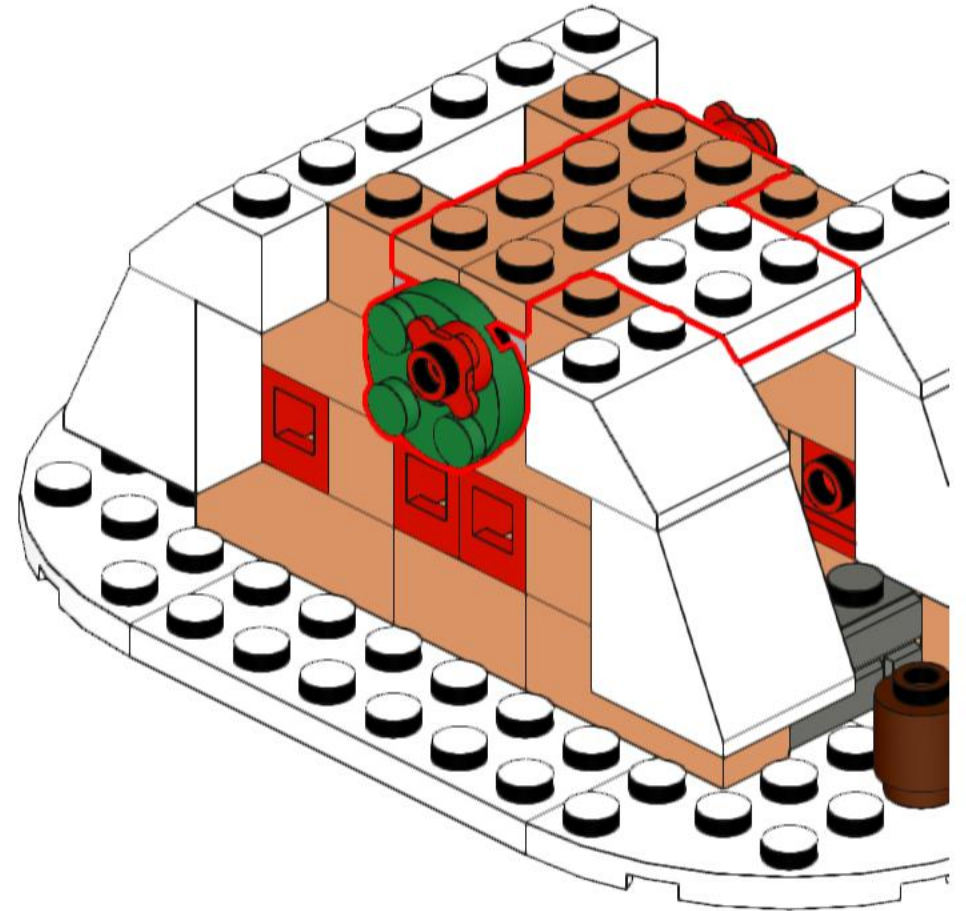
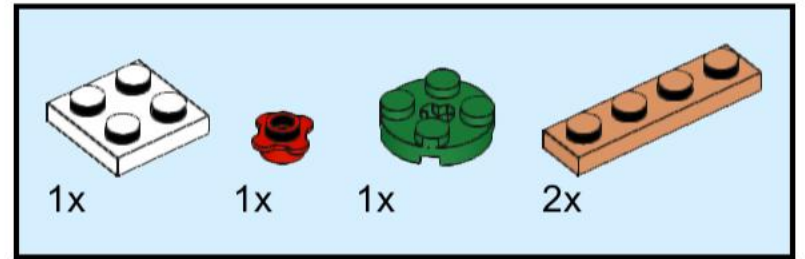

11

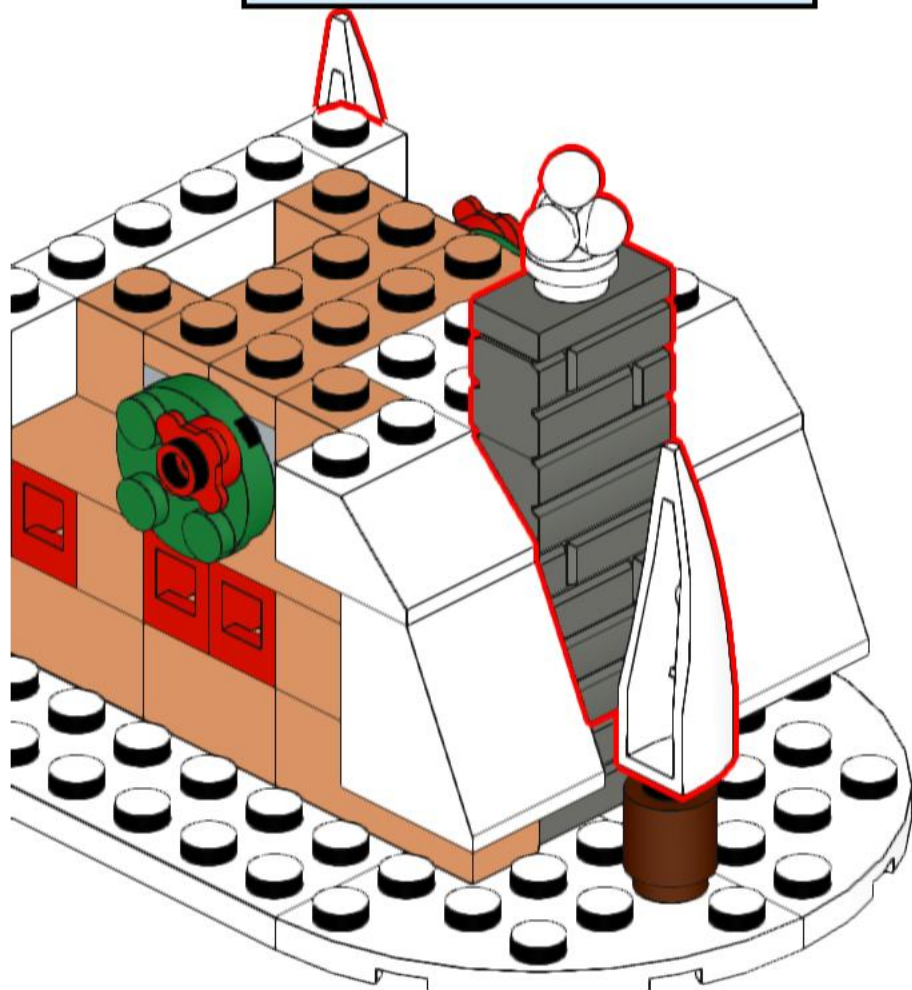
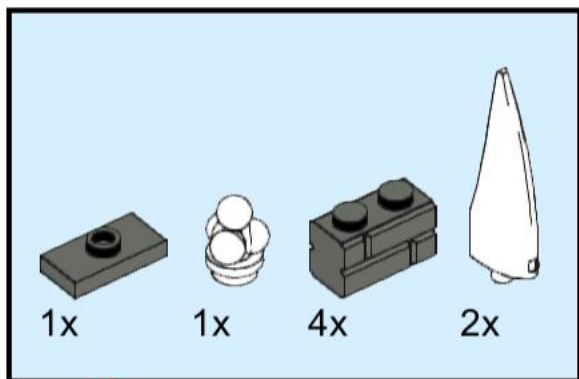

12

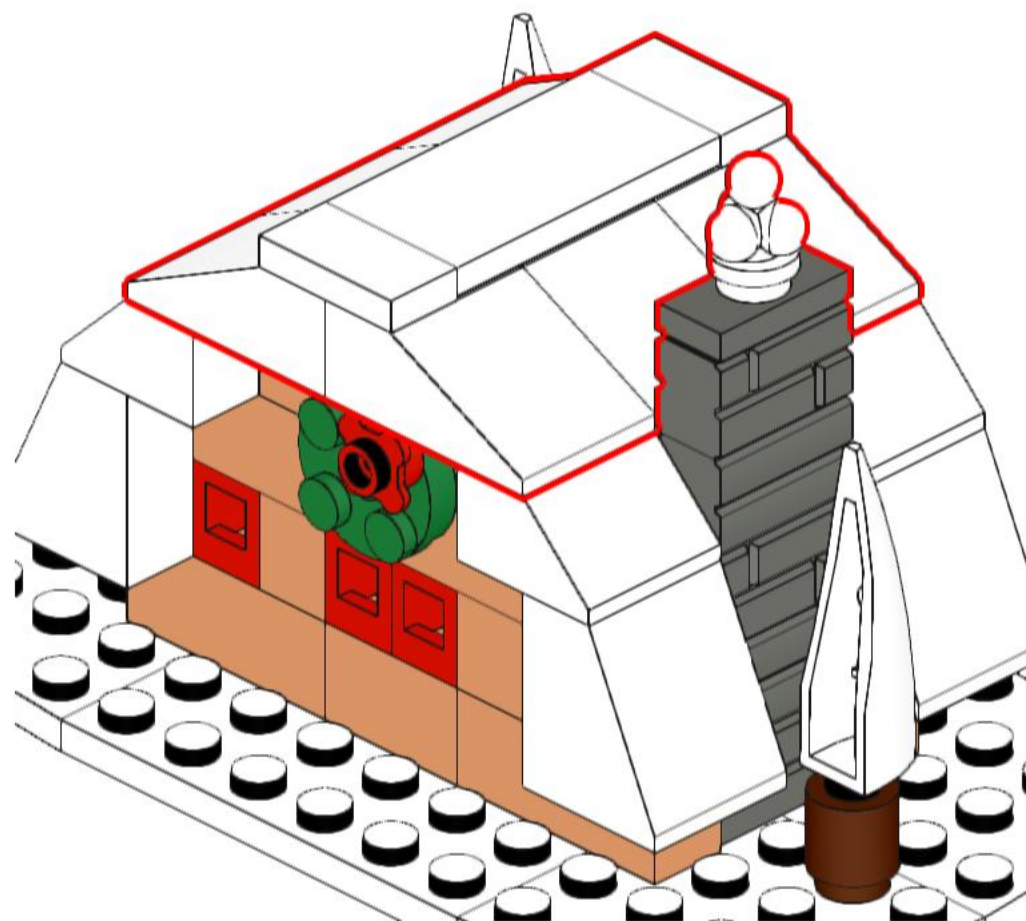
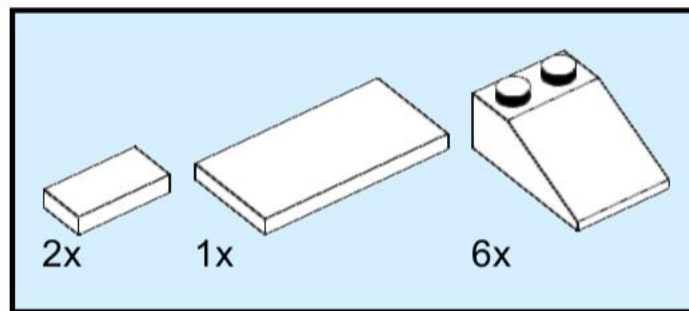

13

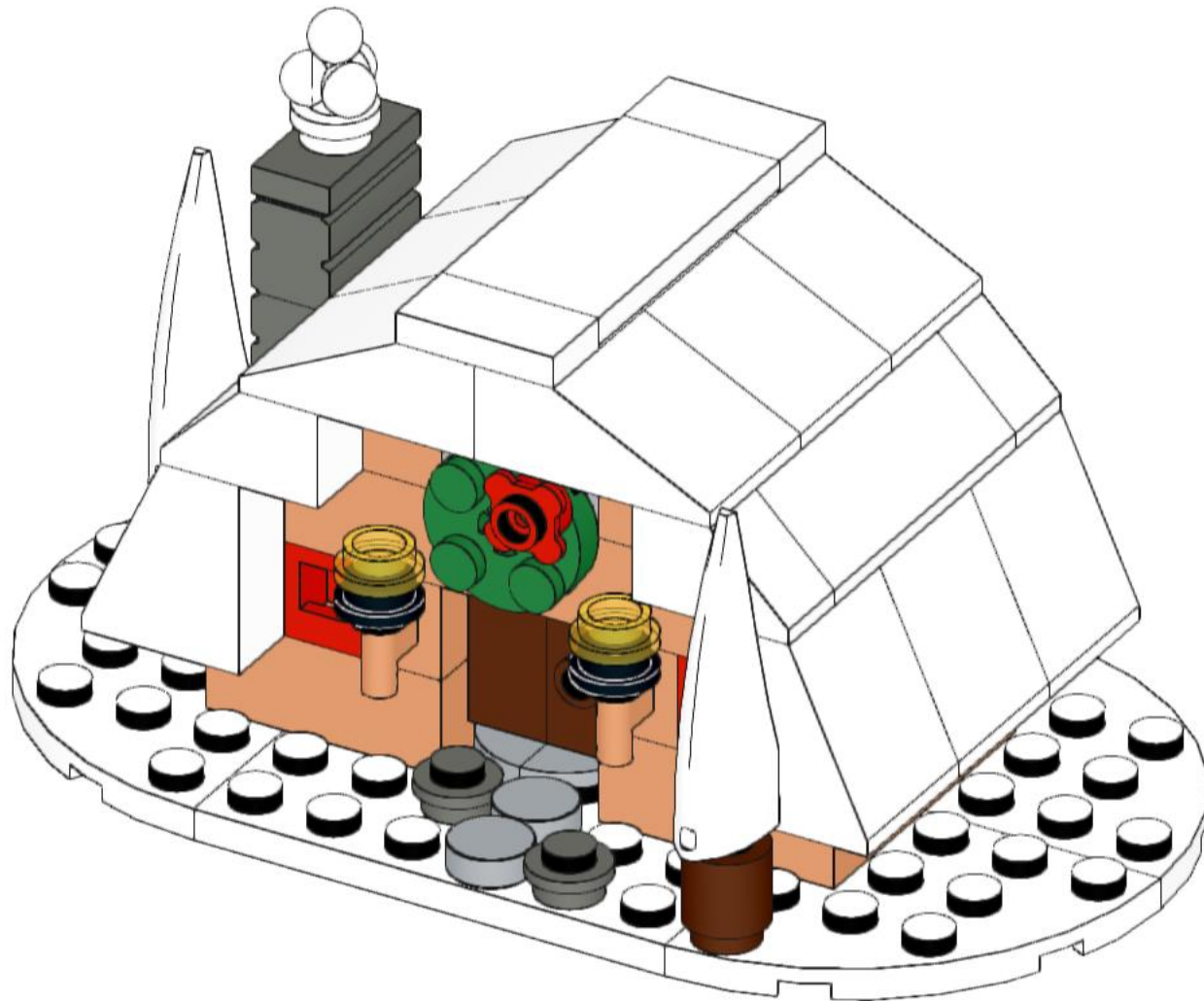



2x
85861, 11

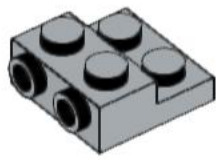

2x
99206, 86

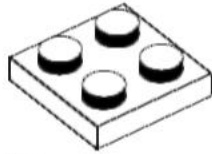

1x
3022, 1

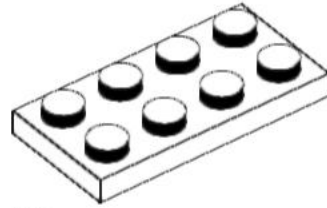

1x
3020, 1



2x
11089, 1



2x
33291, 5



2x
4073, 85

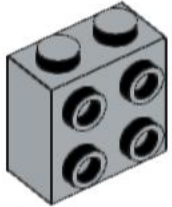

1x
22885, 86

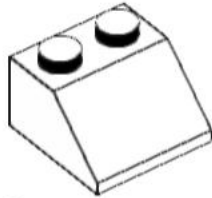

2x
3039, 1

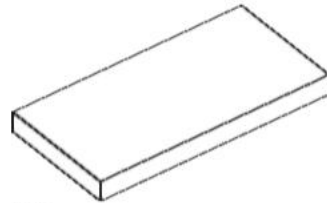

1x
87079, 1

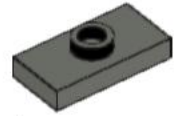

1x
3794b, 85

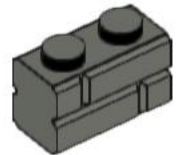

5x
98283, 85



1x
6254, 1

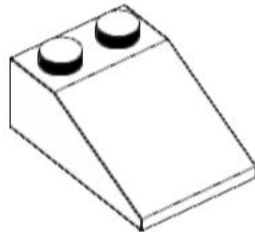

6x
3298, 1

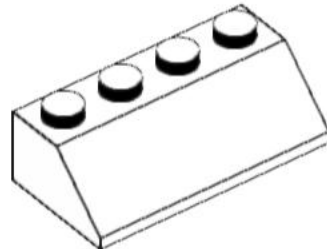

1x
3037, 1

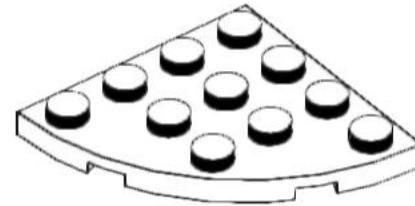

4x
30565, 1



6x
4070, 5



2x
3062b, 88



2x
25269, 86

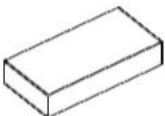

2x
3069a, 1

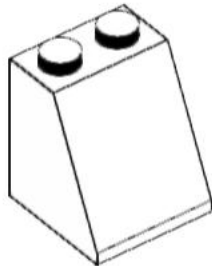

5x
3678b, 1

1x
3037, 1

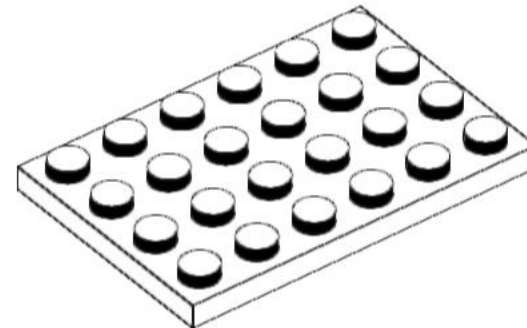

2x
3032, 1

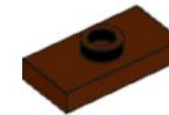

1x
3794b, 88

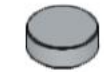

2x
98138, 86

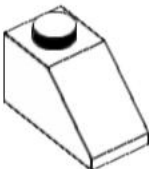

2x
3040, 1



1x
3069a, 88



1x
3023, 88

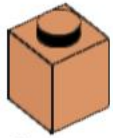

6x
3005, 28

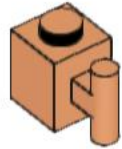

2x
2921, 28

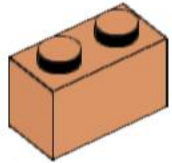

3x
3004, 28

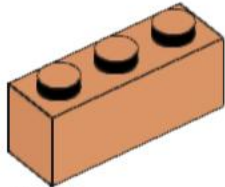

4x
3622, 28

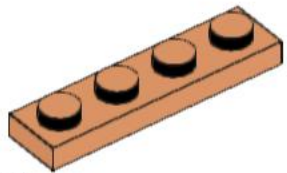

2x
3710, 28

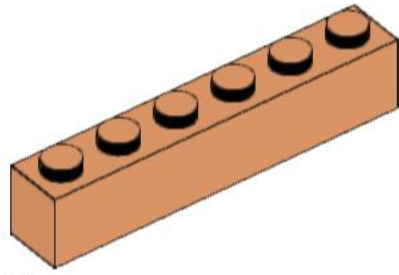

2x
3009, 28



2x
4032b, 6



2x
4073, 19