

1

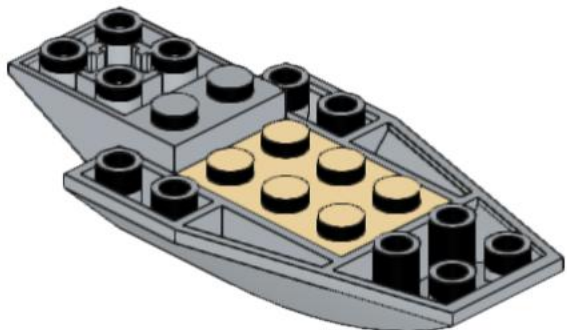

2

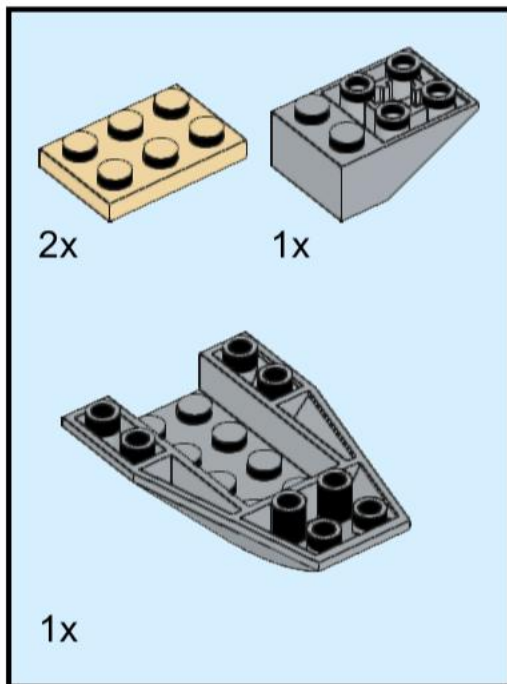
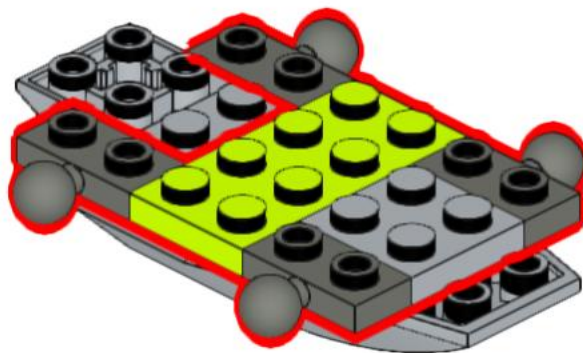
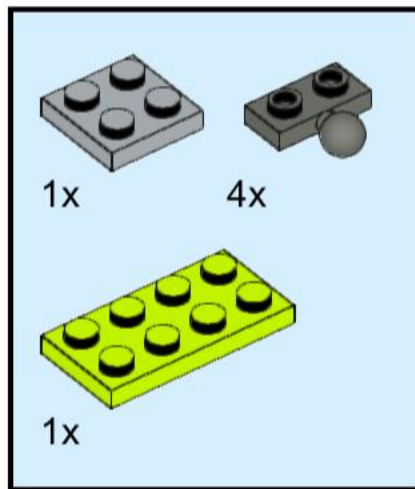

3

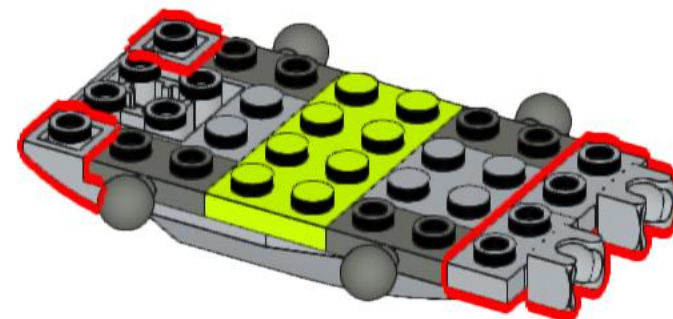
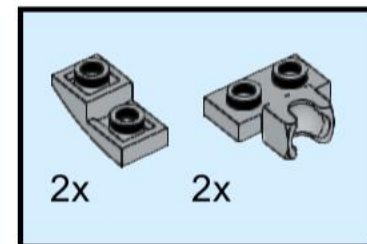

4

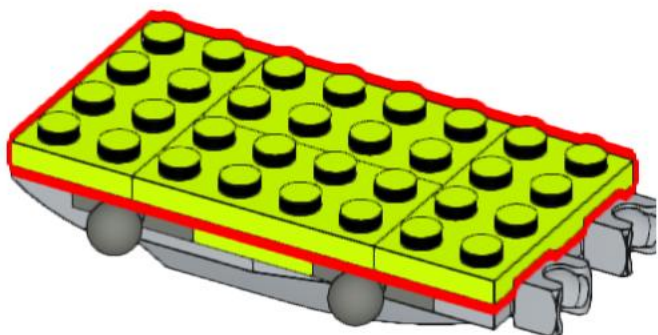
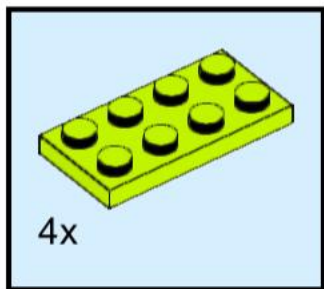

5

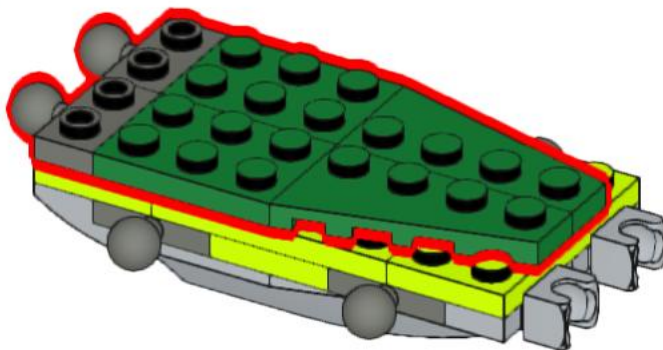
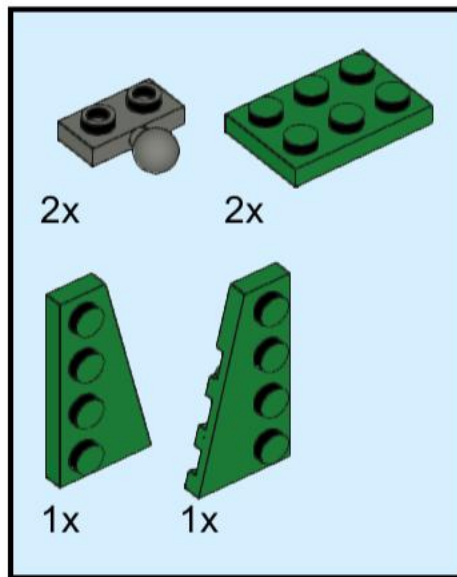

6

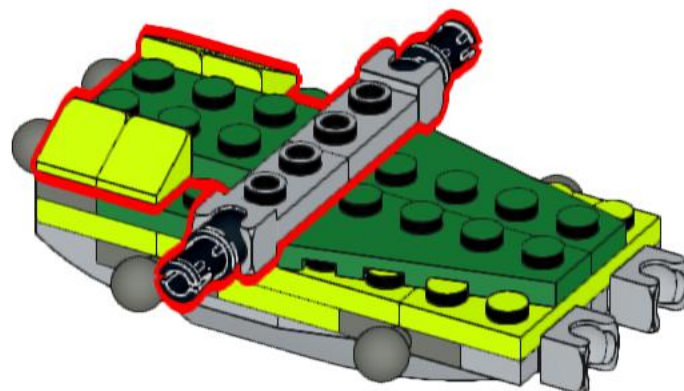
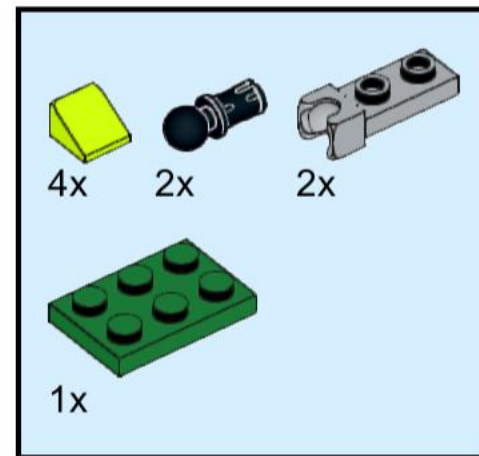

7

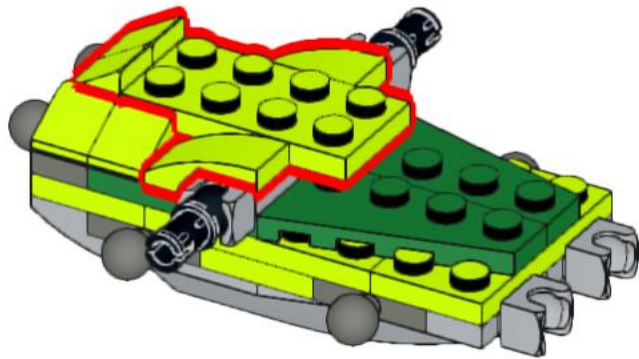
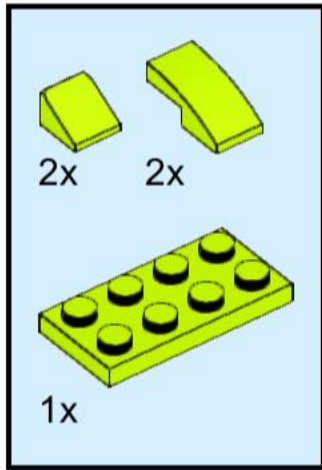

8

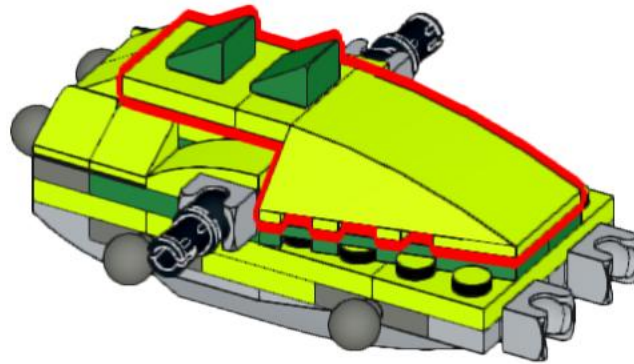
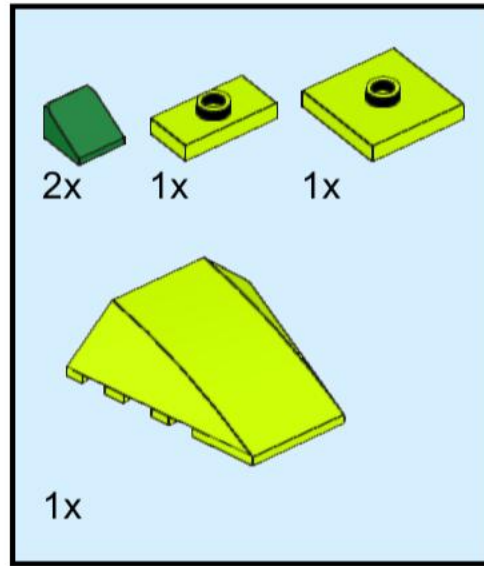

9

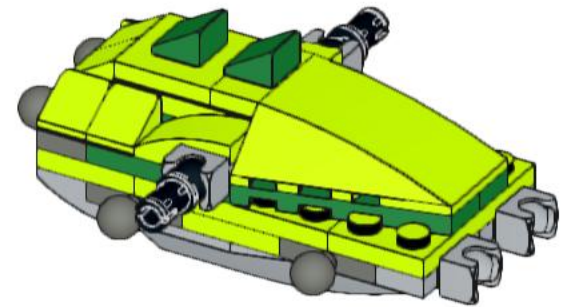

10

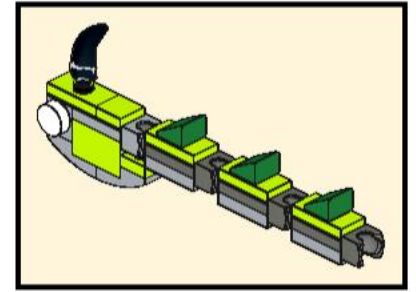
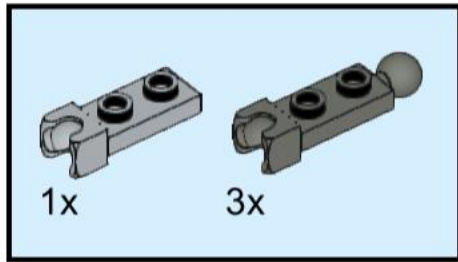

11

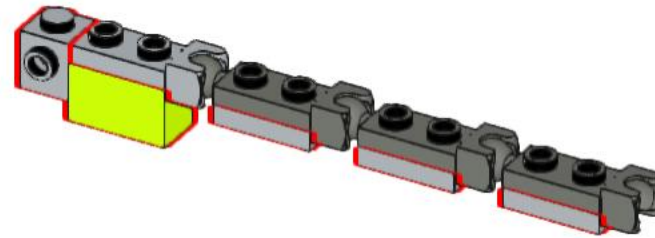
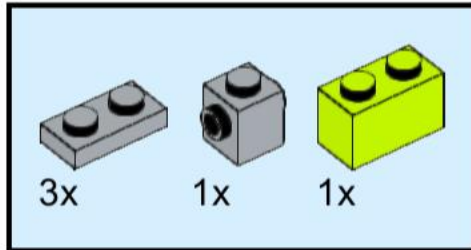

12

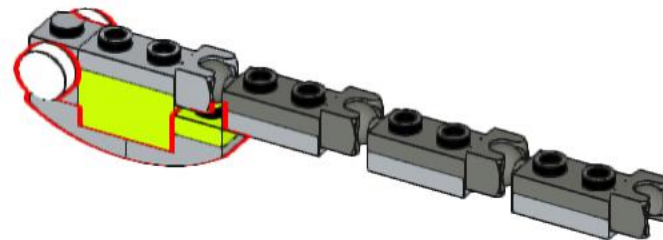
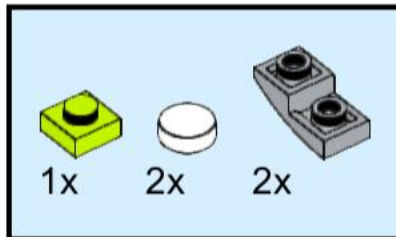

13

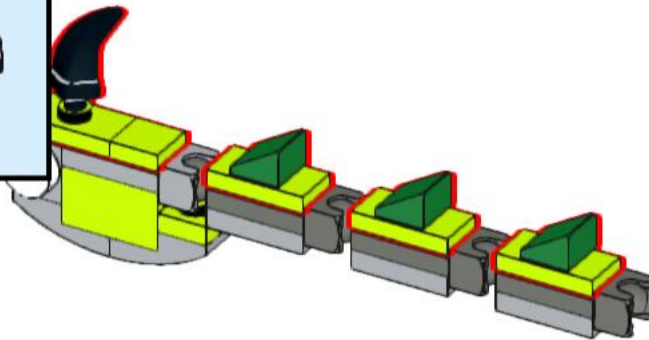
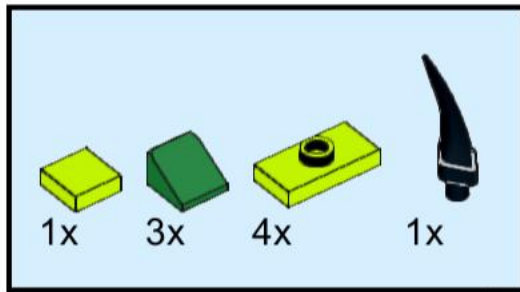

14

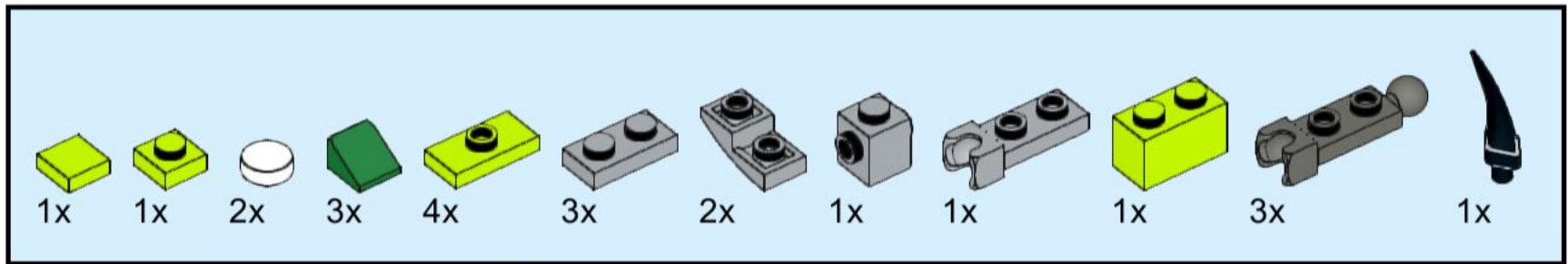

x2

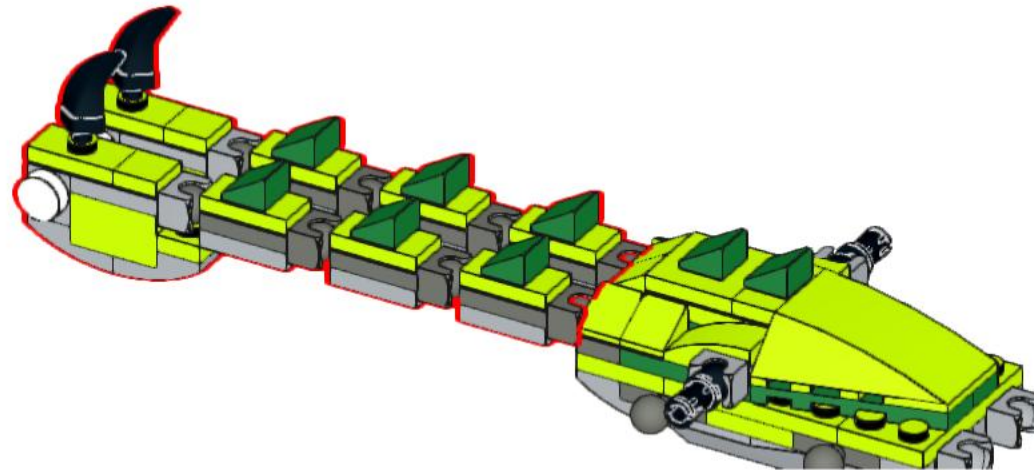

15

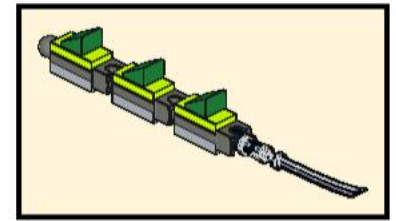
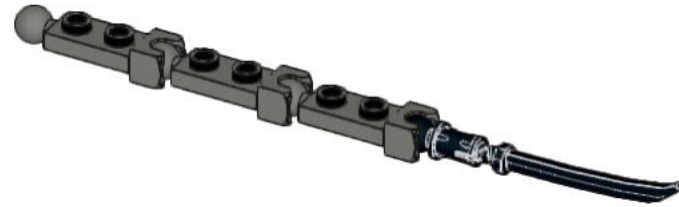
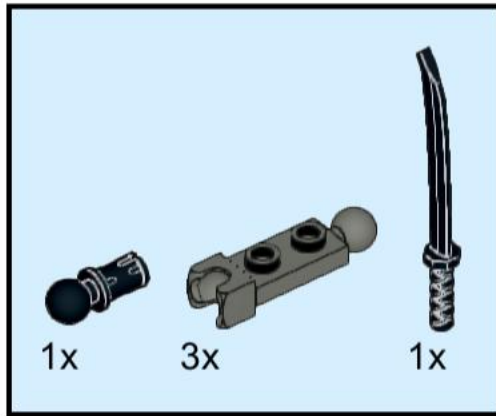

16

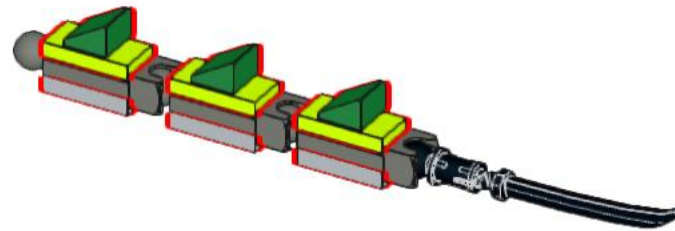
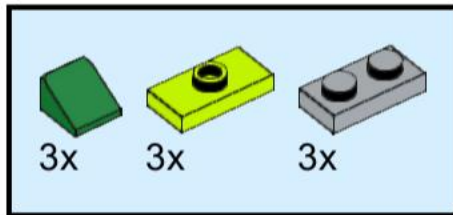

17

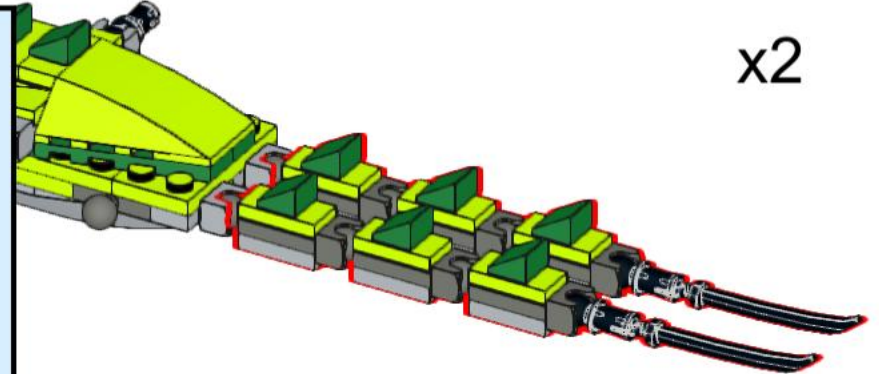

18

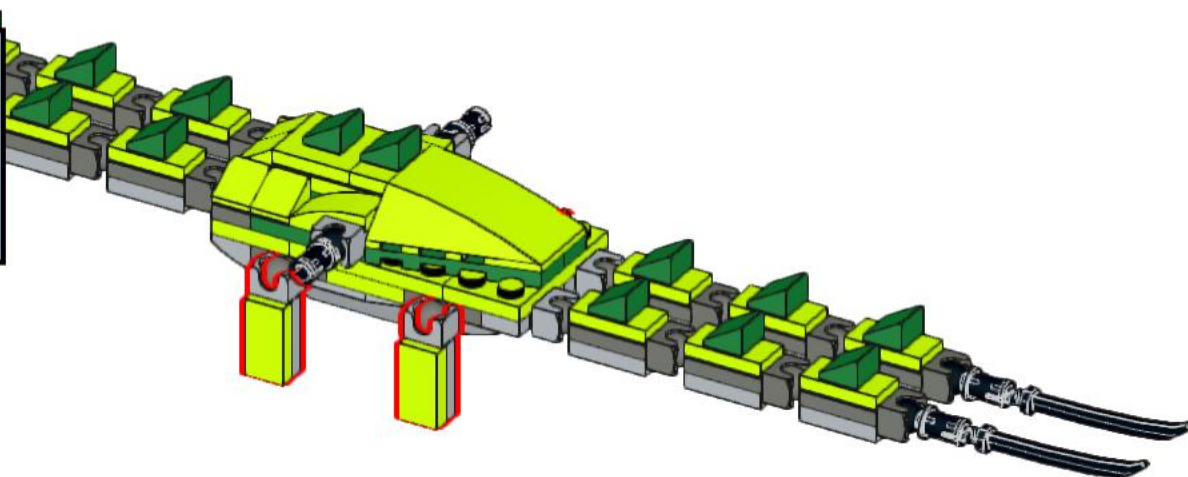
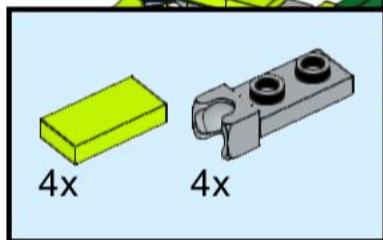

19

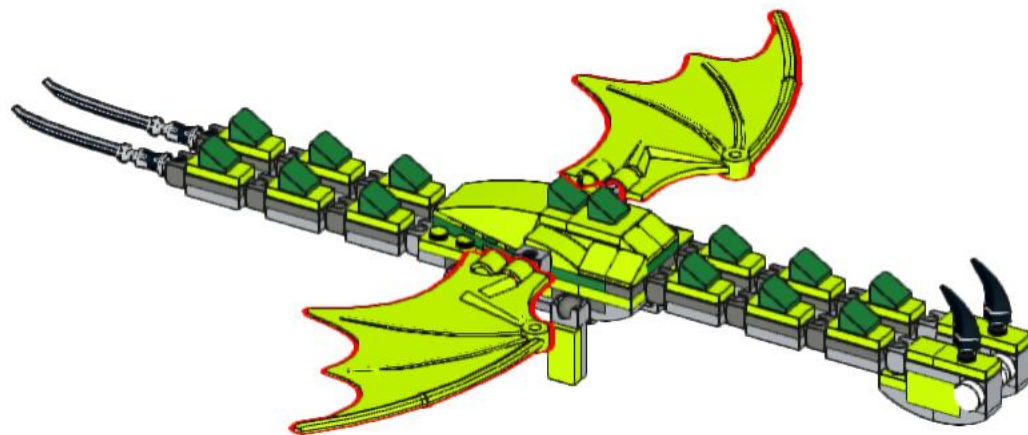
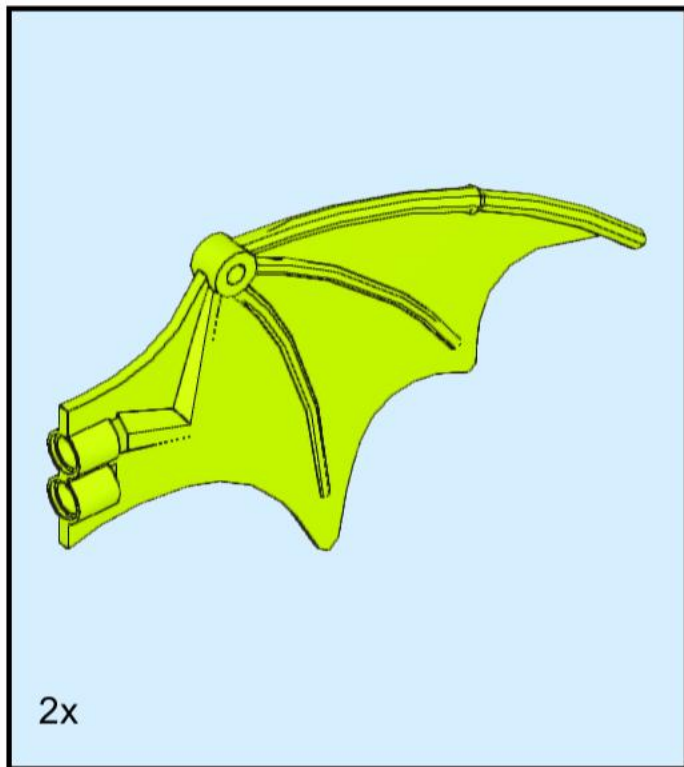

20

